

Armoire Student Desk

Tom Riley
2/19/98
Armstu.SKD

©1998

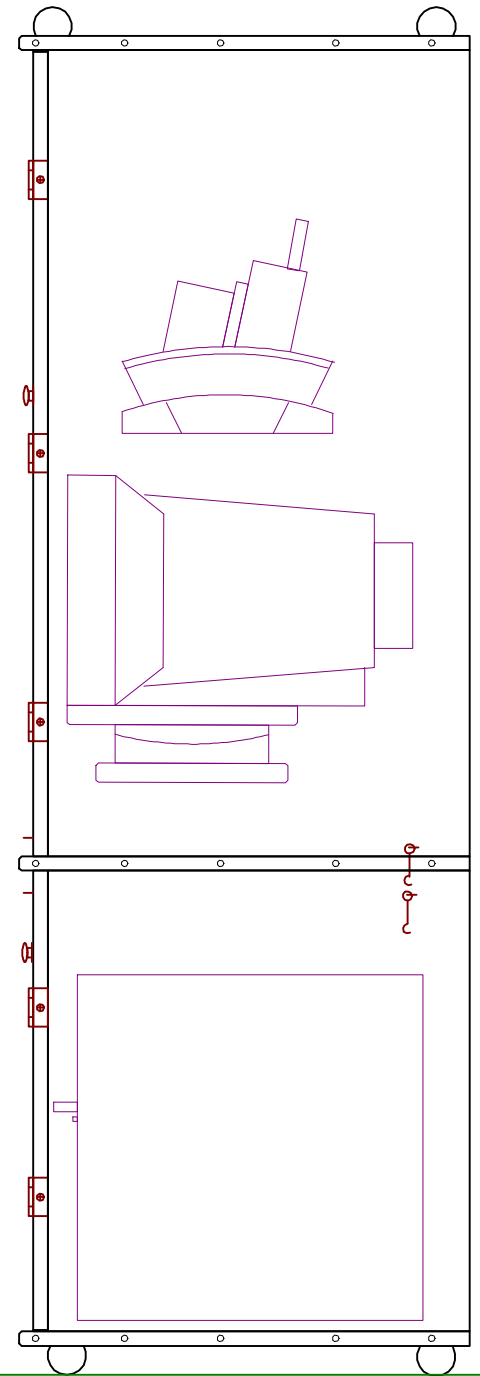

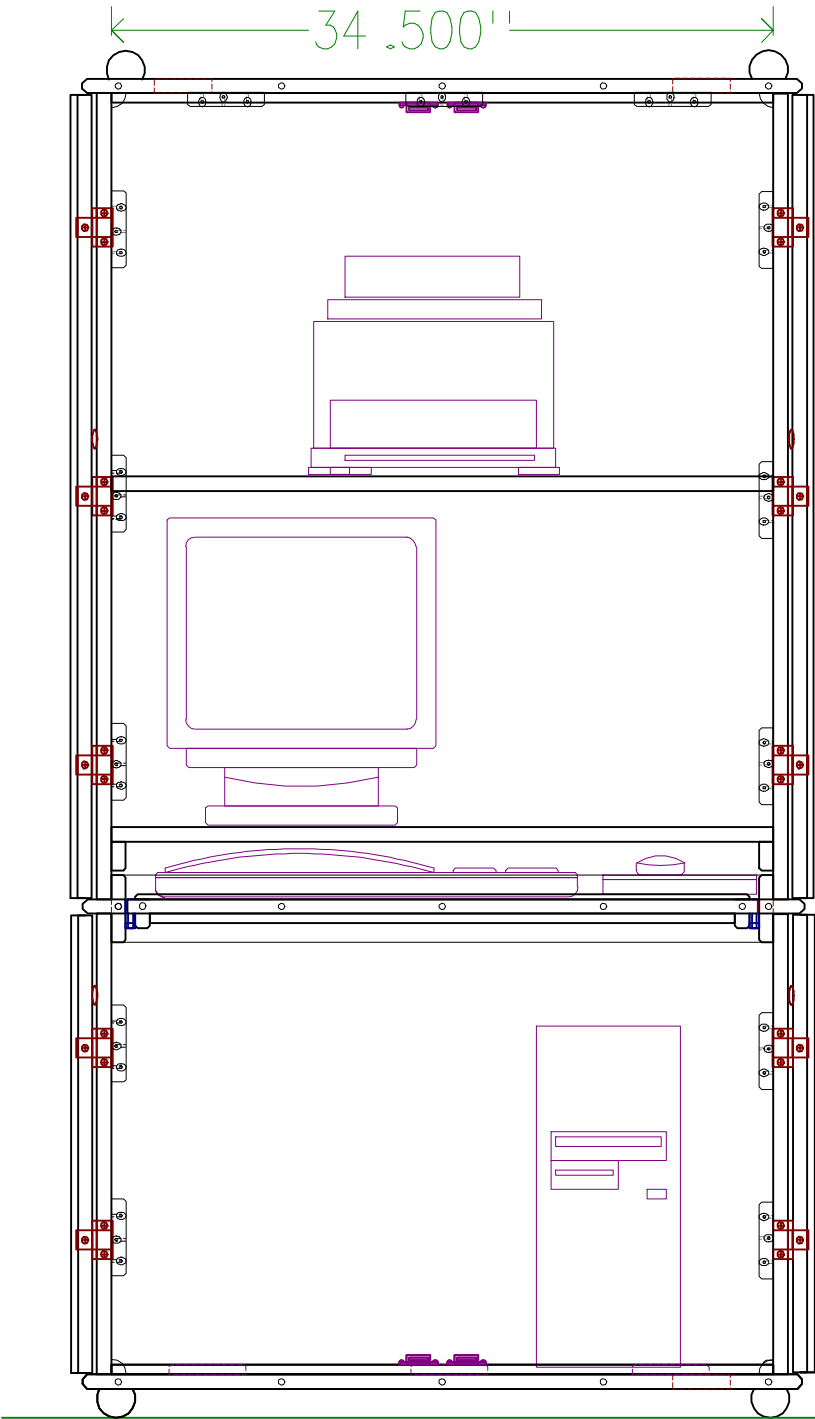

Armoire
Student Desk
Open View
Sketch #2

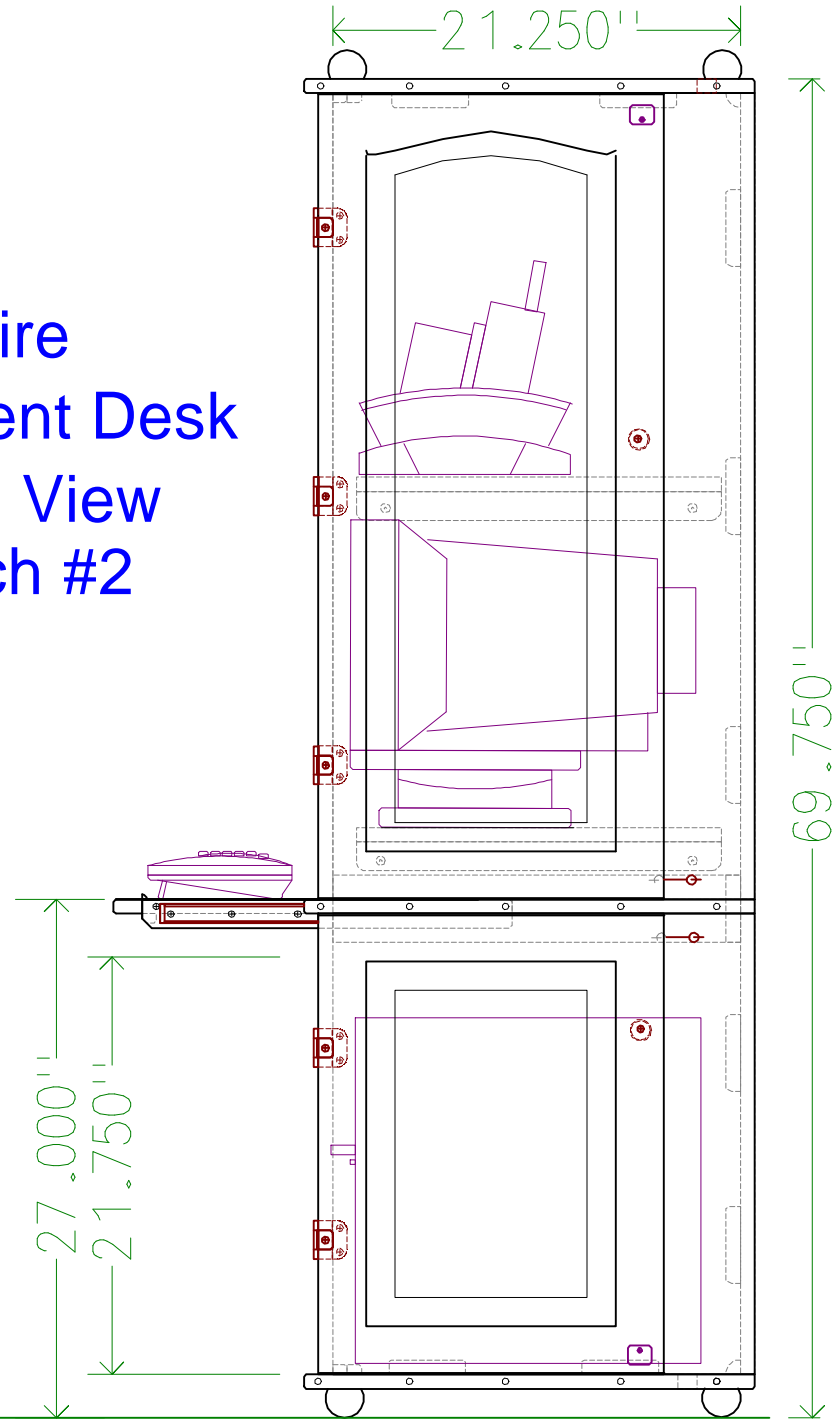

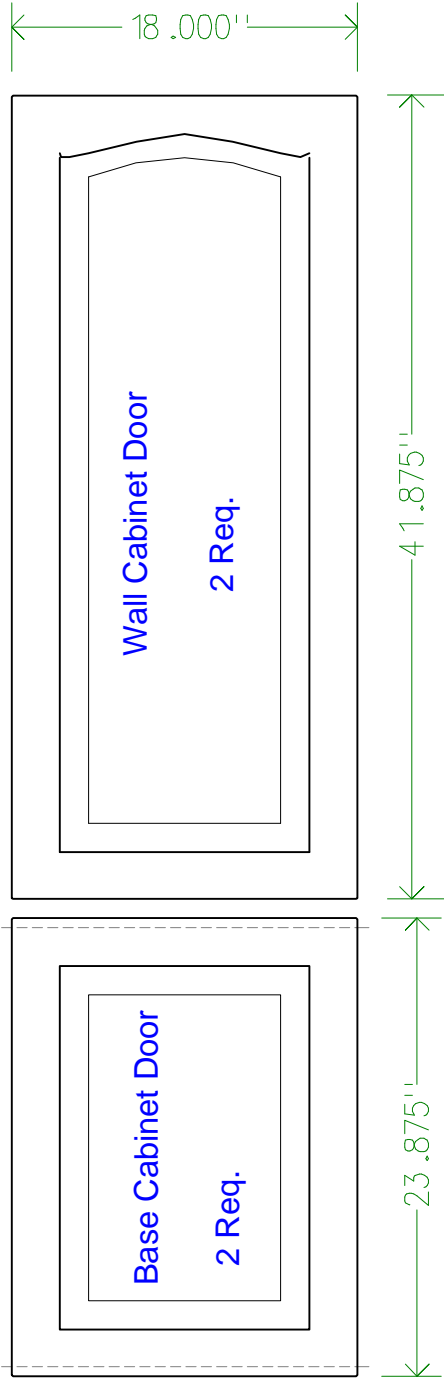

Armoire Student Desk Cabinet Doors Sketch #4

Square Edges

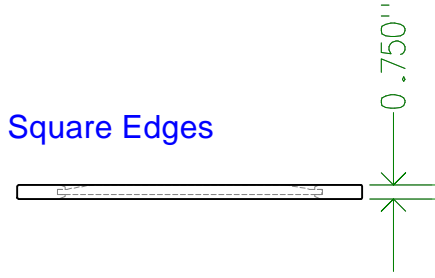

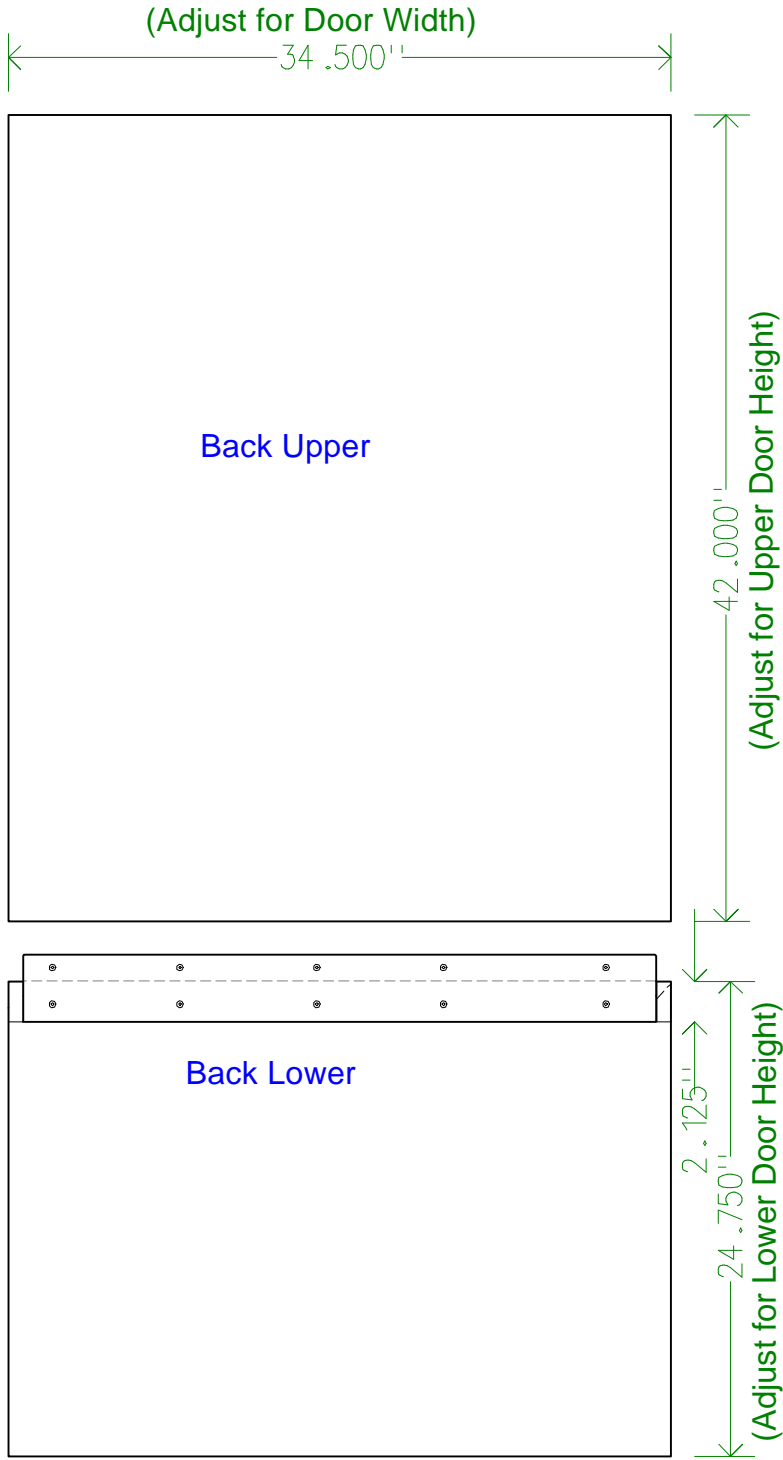

Armoire Student Desk Back & Side Sketch #6

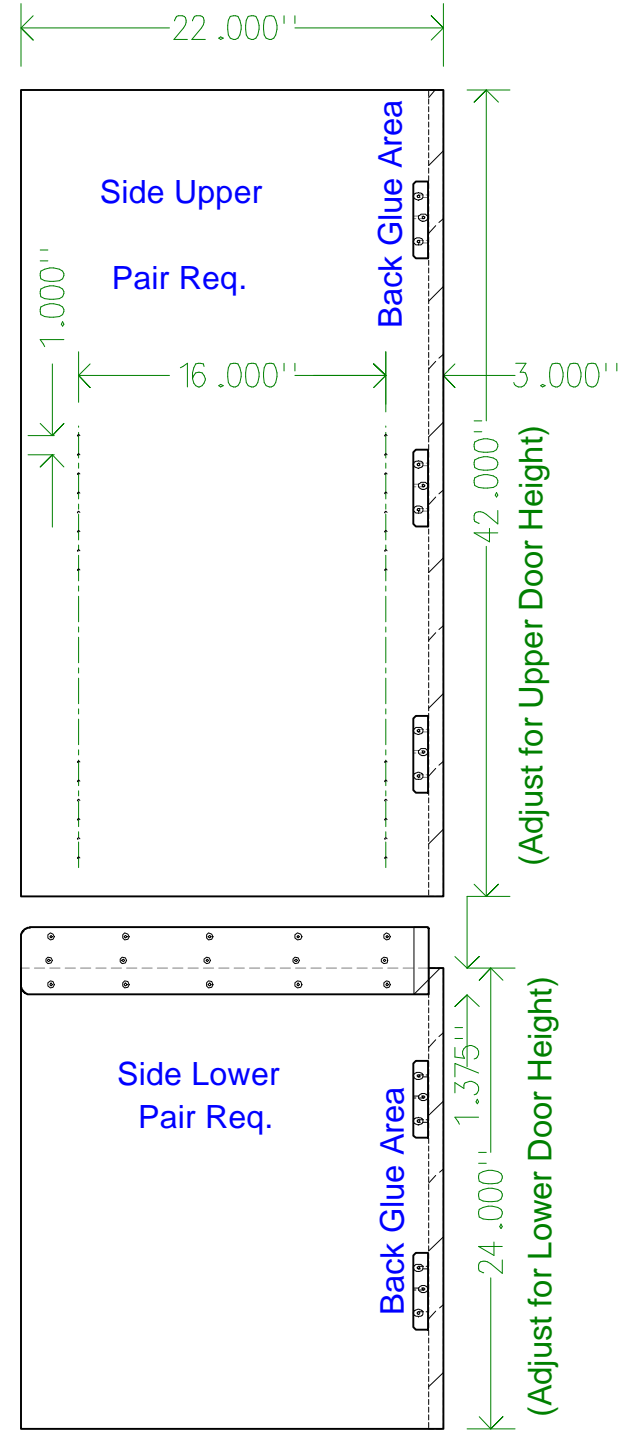

Drawer Guide

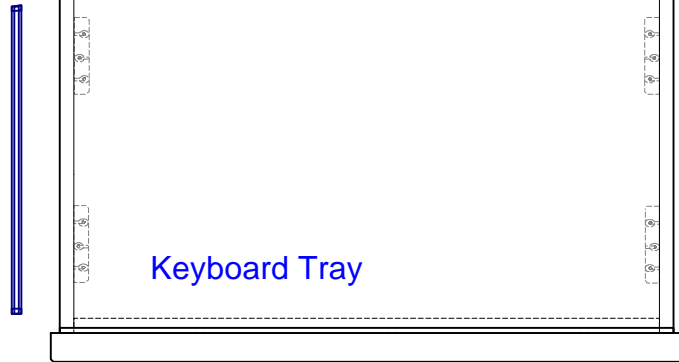

30 .500"

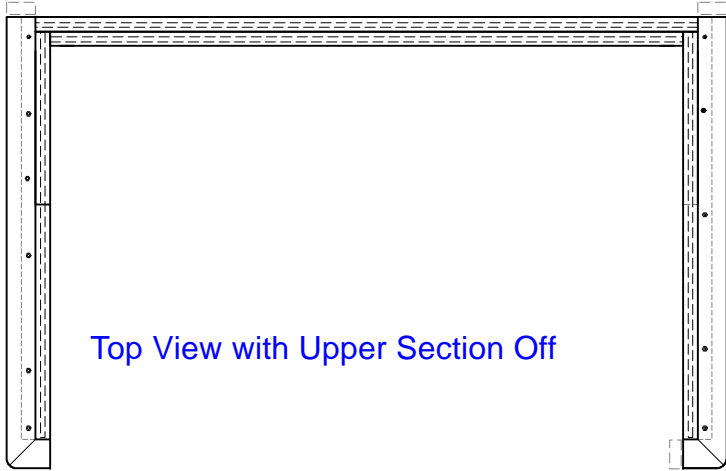

Side View

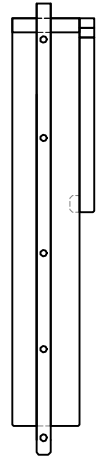

Side View

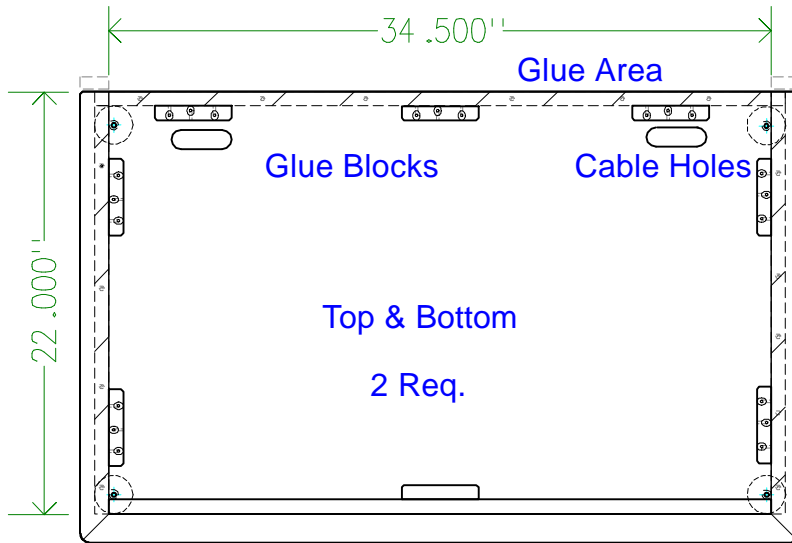

Armoire Student Desk Top Views Sketch #3

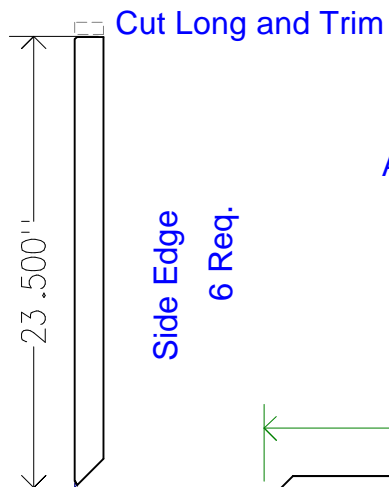

All pieces are .75 by 1.5 hardwood
Angles are 45 degrees

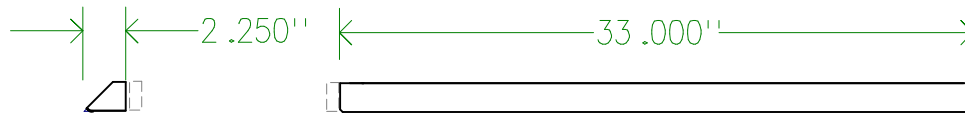

Armoire Student Desk Pieces Sketch #5

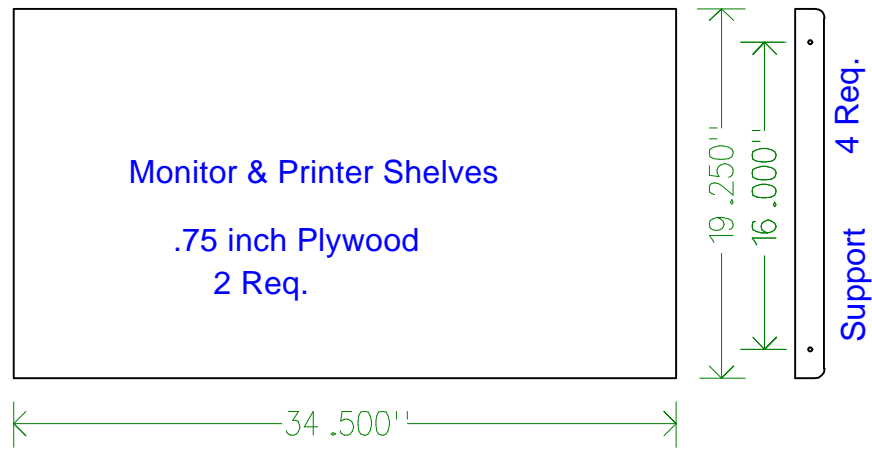
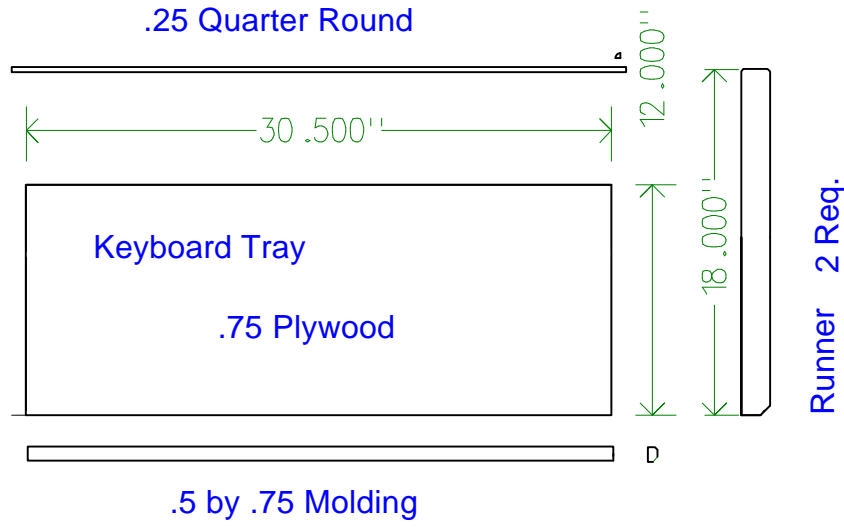

Armoire Student Desk Shelves Sketch #7

Armoire Student Desk Miscellaneous Sketch # 8



Side Splice 2 Req.

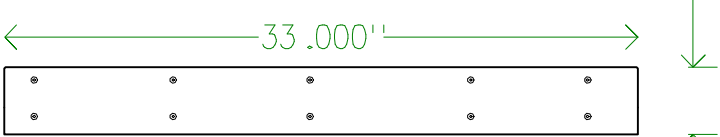

Back Splice



Screw Block
30 Req.



Armoire Student Desk Plywood Layout #1

Sketch #9

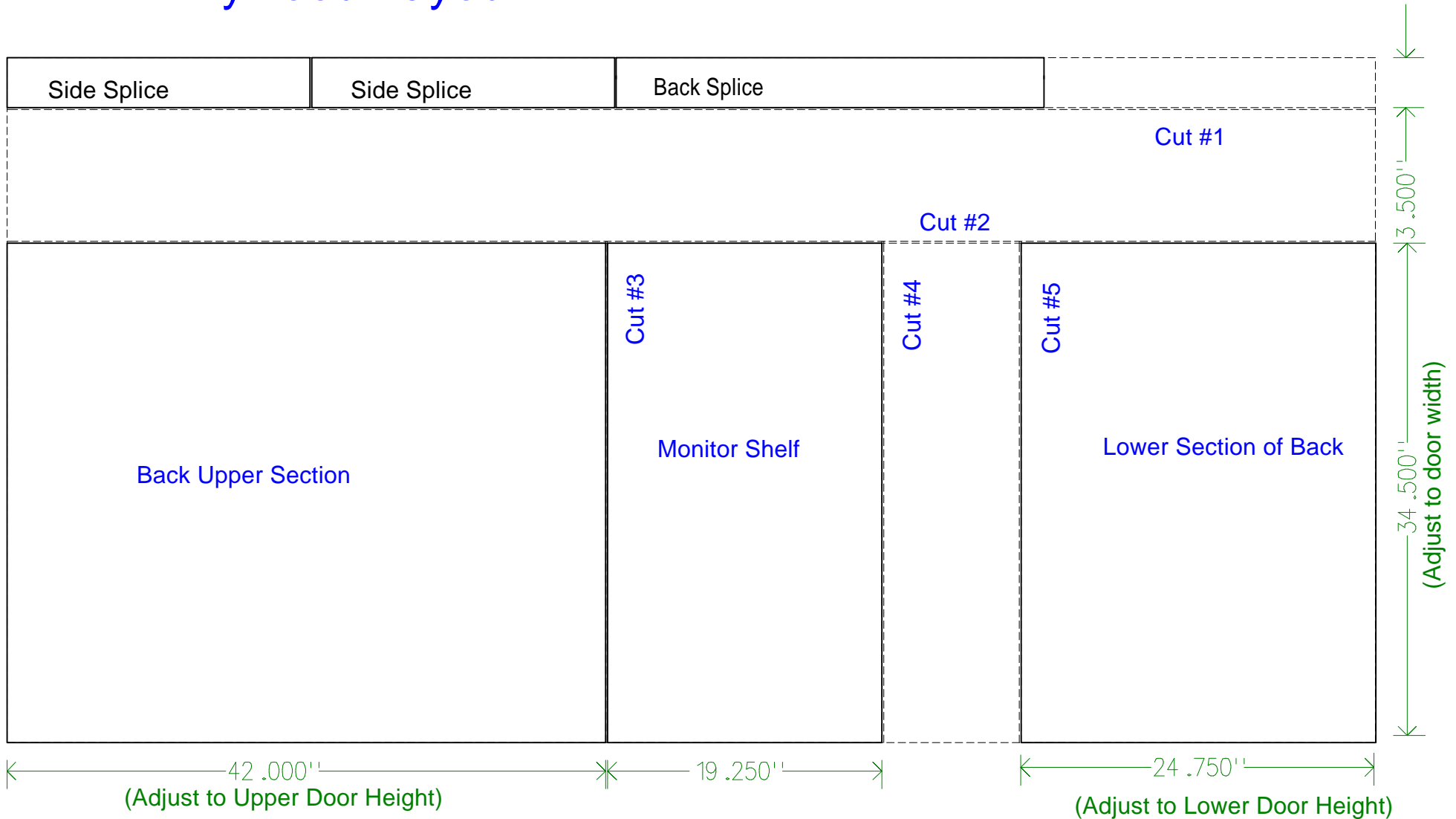

Armoire Student Desk Plywood Layout #2 Sketch #10

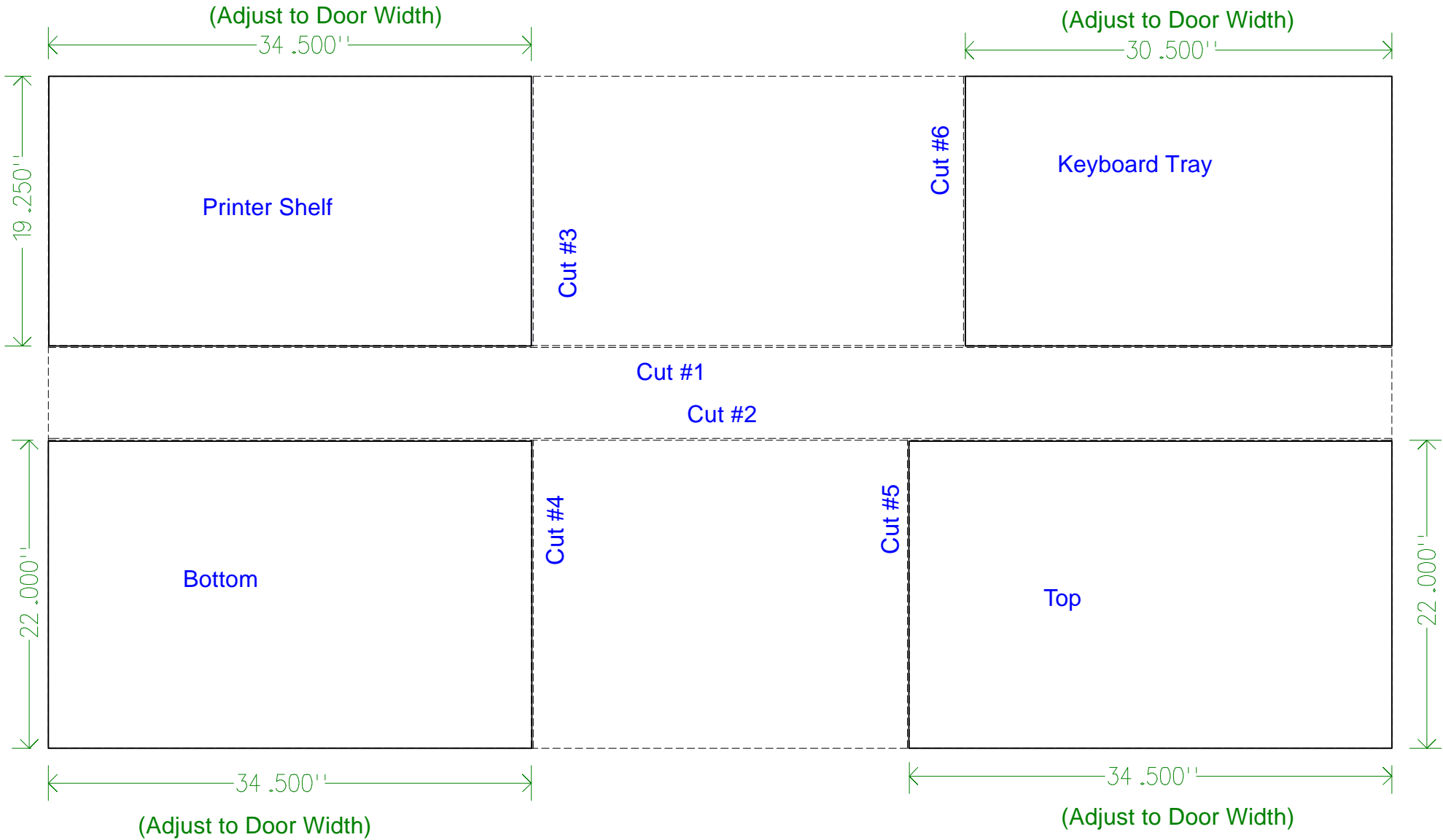

Armoire Student Desk Plywood Layout #3

Sketch #11

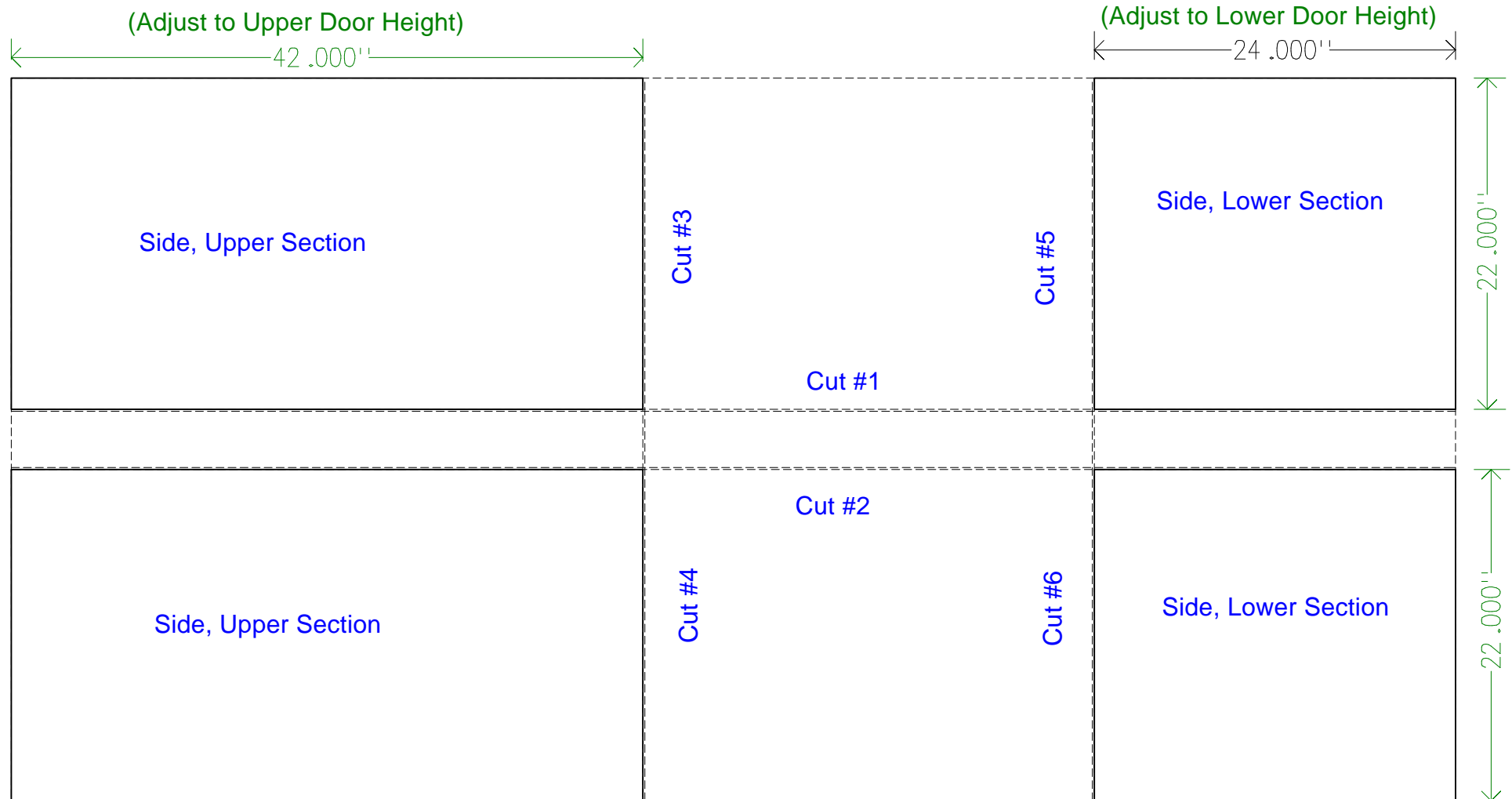

Armoire Student Desk Patterns & Jigs Sketch #12

